



RIGOL

MHO/DHO5000 Series

Digital Oscilloscope

Data Sheet

DSA43100-1110

Oct. 2024

MHO/DHO5000 Series

High-Resolution Digital Oscilloscope

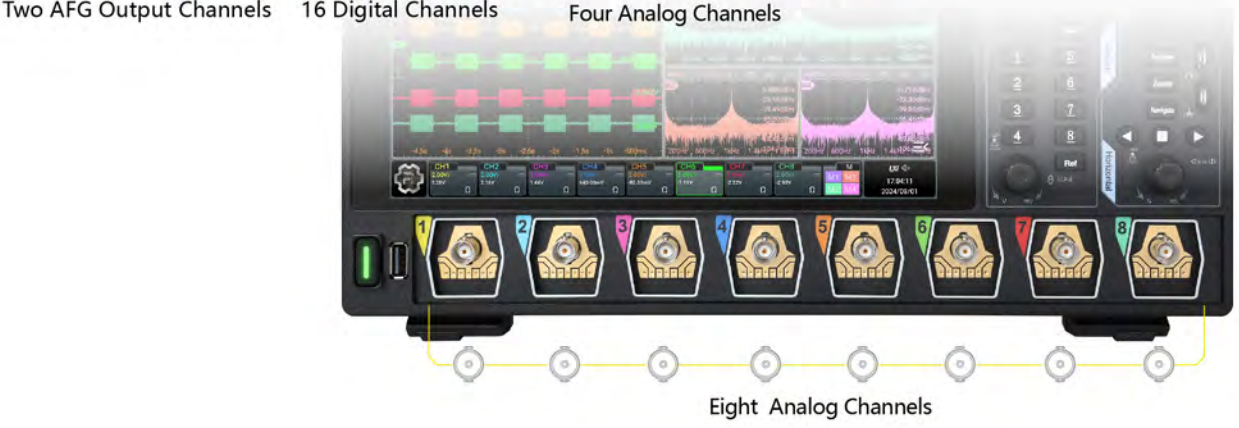



Product Features

Analog Channels: 4/6/8

Analog Bandwidth: 1 GHz

Real-time Sample Rate: 4 GSa/s

Digital Channels (Available for MHO Series): 16

Vertical Resolution: 12-bit

Standard Memory Depth: 500 Mpts

Built-in 2-CH 50 MHz Signal Generator (opt.)



Product Advantages

- Supports up to 8 analog channels: capable of doing highly intensive tests
- High digitalizing bits: details of complex waveforms can be seen clearly
- High integration: integrates many functions including logic analysis, protocol analysis, built-in signal generator, etc.
- Compact size: saves space, 5U height standard for the rack mount installation
- Convenient test schemes: The battery pack-powered instrument makes it convenient to be used for on-site tests or in-vehicle system tests.



Typical Application

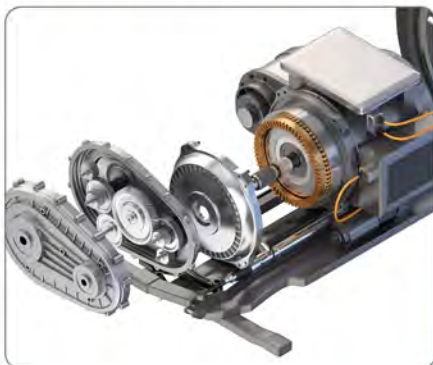

Motor Controller and
Three-Phase Power Analyzer



Power Semi-Conductor Testing



Power Supply Design

Product Features

Product Features

- Based on RIGOL's brand new self-developed Centaurus technical platform
- 12-bit resolution for all the series^[1]
- Max. 1 GHz bandwidth, 8 analog channels, and 1 external trigger channel
- Standard configuration of 16 digital channels (required to purchase the logic analyzer probe) for the MHO models
- Real-time sample rate: up to 4 GSa/s
- Max. memory depth 500 Mpts
- Vertical sensitivity up to 100 $\mu\text{V}/\text{div}$
- Maximum waveform capture rate of 1,000,000 wfms/s in fast recording mode
- Arbitrary Waveform/Function Generator (AFG)^[2], power analysis, histogram, and digital signal analysis^[3], Bode plot^[4], and protocol decodings
- Search and navigation function helps users quickly search for the signals with exceptions and locate them accurately.
- 256-level intensity grading display, with digital real-time fluorescence technology
- 10.1" 1280*800 high-definition touch screen
- Brand new Flex knob brings friendly user experience
- Standard configuration of USB Device, USB Host, LAN, HDMI interfaces for all the series
- Battery pack-powered, convenient to charge anytime and anywhere, providing a great feasibility for measurement
- Online upgrade
- Standard configuration of the photoelectric encoder operating knob for all the series to improve the service life of the instrument

The MHO/DHO5000 series is a 8-CH high-resolution digital oscilloscope designed for the vast mainstream digital oscilloscope market to meet the design, debugging, and test demands. It is developed based on RIGOL's brand new self-developed Centaurus technical platform. Its 1,000,000 wfms/s waveform capture rate (in fast recording mode), 500 Mpts memory depth, 12-bit resolution, excellent noise floor and vertical measurement accuracy can meet the test demands for higher accuracy. The MHO/DHO5000 series digital oscilloscope has multiple models, supporting AFG, digital signal analysis, Bode plot, and other functions. It is powered by battery pack, convenient to operate and control, applicable for various complex test scenarios.

Note:

[1]: Up to 16-bit in high resolution mode.

[2]: AFG is only available for MHO5054 and MHO5104 models.

[3]: Digital signal analysis is only available for the MHO series.





[4]: The Bode plot function is only available for MHO5054 and MHO5104 models.







Overview of RIGOL's Medium-end Series Products







	DHO1000U	DHO1000	DHO4000	MHO/DHO5000
Analog channel	2/4 + EXT	2/4 + EXT	4 + EXT	4/6/8 + EXT
Digital Channel	N/A	N/A	N/A	Standard for MHO series
Analog Bandwidth	200 MHz	200 MHz	800 MHz	1 GHz
Max. Sample Rate	2 GSa/s	2 GSa/s	4 GSa/s	4 GSa/s
Max. Memory Depth	50 Mpts	100 Mpts (option)	500 Mpts (option)	500 Mpts
Waveform Capture Rate	≤500,000 wfms/s	≤1,500,000 wfms/s	≤1,500,000 wfms/s	≤1,000,000 wfms/s
Max. Frames of Waveform Recording	500,000	500,000	500,000	500,000
LCD	10.1" High-Definition Touch Screen	10.1" High-Definition Touch Screen	10.1" High-Definition Touch Screen	10.1" High-Definition Touch Screen
Hardware Mask Test	Standard	Standard	Standard	Standard
Built-in Arbitrary Waveform Generator	N/A	N/A	N/A	Option
Built-in Digital Voltmeter	Standard	Standard	Standard	Standard
Built-in Hardware Counter	6-digit frequency counter + totalizer	6-digit frequency counter + totalizer	6-digit frequency counter + totalizer	6-digit frequency counter + totalizer
Search and Navigation	Supports table display	Supports table display	Supports table display	Supports table display
Power Analysis	N/A	N/A	Option	Option
Histogram	N/A	N/A	N/A	Standard
Serial Protocol Analysis	RS232/UART, I2C, SPI, CAN, CAN-FD, LIN, FlexRay, I2S, and MIL-STD-1553	RS232/UART, I2C, SPI, CAN, CAN-FD, LIN, FlexRay, I2S, and MIL-STD-1553	RS232/UART, I2C, SPI, CAN, CAN-FD, LIN, FlexRay, I2S, and MIL-STD-1553	RS232/UART, I2C, SPI, CAN, CAN-FD, LIN, FlexRay, I2S, and MIL-STD-1553
Waveform Color Persistence	Standard	Standard	Standard	Standard
FFT	FFT, standard	FFT, standard	FFT, standard	FFT, standard

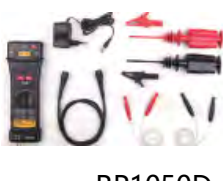



	DHO1000U	DHO1000	DHO4000	MHO/DHO5000
MATH	Displays 4 functions at the same time	Displays 4 functions at the same time	Displays 4 functions at the same time	Displays 4 functions at the same time
Connectivity	Standard: USB, LAN, and HDMI	Standard: USB, LAN, and HDMI	Standard: USB, LAN, and HDMI	Standard: USB, LAN, and HDMI

RIGOL Probes and Accessories Supported by the Series





Model	Type	Description
Passive High-impedance Probe		
 <p>PVP2150</p>	Passive High-impedance Probe	<ul style="list-style-type: none"> • Attenuation Ratio: 10:1/1:1 • 1X BW: DC to 35 MHz • 10X BW: DC to 150 MHz • Compatibility: All models of RIGOL's digital oscilloscopes
 <p>PVP2350</p>	Passive High-impedance Probe	<ul style="list-style-type: none"> • Attenuation Ratio: 10:1/1:1 • 1X BW: DC to 35 MHz • 10X BW: DC to 350 MHz • Compatibility: All models of RIGOL's digital oscilloscopes
 <p>PVP3150</p>	Passive High-impedance Probe	<ul style="list-style-type: none"> • Attenuation Ratio: 10:1/1:1 • 1X BW: DC to 20 MHz • 10X BW: DC to 150 MHz • Compatibility: All models of RIGOL's digital oscilloscopes
 <p>RP3500A</p>	Passive High-impedance Probe	<ul style="list-style-type: none"> • Attenuation Ratio: 10:1 • BW: DC to 500 MHz • Compatibility: MSO/DS7000, MSO8000/A, DHO4000/1000, MHO/DHO5000, and DS70000/80000 series
High-voltage Single-ended Probe		
 <p>RP1010H</p>	High-voltage Probe	<ul style="list-style-type: none"> • Attenuation Ratio: 1000:1 • BW: DC to 40 MHz • DC: 0 to 10 kV DC • AC: pulse ≤ 20 kVp-p • AC: sine ≤ 7 kV_{rms} • Compatibility: All models of RIGOL's digital oscilloscopes

Model	Type	Description
 <p>RP1018H</p>	High-voltage Probe	<ul style="list-style-type: none"> • Attenuation Ratio: 1000:1 • BW: DC to 150 MHz • DC+AC_{peak}: 18 kV CAT II • AC_{rms}: 12 kV CAT II • Compatibility: All models of RIGOL's digital oscilloscopes
 <p>RP1300H</p>	High-voltage Probe	<ul style="list-style-type: none"> • Attenuation Ratio: 100:1 • BW: DC to 300 MHz • CAT I 2000 V (DC+AC) • CAT II 1500 V (DC+AC) • Compatibility: All models of RIGOL's digital oscilloscopes
High-voltage Differential Probe		
 <p>PHA0150</p>	High-voltage Differential Probe	<ul style="list-style-type: none"> • BW: DC to 70 MHz • Max. voltage ≤ 1500 Vpp • Compatibility: All models of RIGOL's digital oscilloscopes
 <p>PHA1150</p>	High-voltage Differential Probe	<ul style="list-style-type: none"> • BW: DC to 100 MHz • Max. voltage ≤ 1500 Vpp • Compatibility: All models of RIGOL's digital oscilloscopes
 <p>PHA2150</p>	High-voltage Differential Probe	<ul style="list-style-type: none"> • 50X BW: DC to 160 MHz • 500X BW: DC to 200 MHz • Max. voltage ≤ 1500 Vpp • Compatibility: All models of RIGOL's digital oscilloscopes
 <p>RP1025D</p>	High-voltage Differential Probe	<ul style="list-style-type: none"> • BW: DC to 25 MHz • Max. voltage ≤ 1400 Vpp (DC + AC P-P) • Compatibility: All models of RIGOL's digital oscilloscopes
 <p>RP1050D</p>	High-voltage Differential Probe	<ul style="list-style-type: none"> • BW: DC to 50 MHz • Max. voltage ≤ 7000 Vpp (DC + AC P-P) • Compatibility: All models of RIGOL's digital oscilloscopes

Model	Type	Description
 RP1100D	High-voltage Differential Probe	<ul style="list-style-type: none"> BW: DC to 100 MHz Max. voltage ≤ 7000 Vpp (DC + AC P-P) Compatibility: All models of RIGOL's digital oscilloscopes
Low-voltage Differential Probe		
 RP7080	Low-voltage Differential Probe	<ul style="list-style-type: none"> Input Dynamic Range: ± 6.25 V BW: DC to 800 MHz 30 V peak CAT I Compatibility: MSO/DS7000, MSO8000/A, DHO4000, MHO/DHO5000, and DS70000/80000 series
 RP7150	Low-voltage Differential Probe	<ul style="list-style-type: none"> Input Dynamic Range: ± 6.25 V BW: DC to 1.5 GHz 30 V peak CAT I Compatibility: MSO/DS7000, MSO8000/A, DHO4000, MHO/DHO5000, and DS70000/80000 series
 PVA7250	Low-voltage Differential Probe	<ul style="list-style-type: none"> Input Dynamic Range: ± 2 V BW: DC to 2.5 GHz 30 V peak CAT I Compatibility: MSO/DS7000, MSO8000/A, DHO4000, MHO/DHO5000, and DS70000/80000 series
Low-voltage Single-ended Probe		
 RP7080S	Single-ended Active Probe	<ul style="list-style-type: none"> Input Dynamic Range: ± 6.25 V BW: DC to 800 MHz 30 V peak CAT I Compatibility: MSO/DS7000, MSO8000/A, DHO4000, MHO/DHO5000, and DS70000/80000 series
 RP7150S	Single-ended Active Probe	<ul style="list-style-type: none"> Input Dynamic Range: ± 6.25 V BW: DC to 1.5 GHz 30 V peak CAT I Compatibility: MSO/DS7000, MSO8000/A, DHO4000, MHO/DHO5000, and DS70000/80000 series

Model	Type	Description
 <p>PVA8150S</p>	High-impedance Single-ended Active Probe	<ul style="list-style-type: none"> BW: ≥ 1.5 GHz Input Impedance: $1\text{ M}\Omega$ Input Capacitance: $\leq 1\text{ pF}$ Compatibility: MSO8000/A, DHO4000/1000, MHO/DHO5000, DS70000/80000 series
Current Probe		
 <p>PCA1030</p>	Current Probe	<ul style="list-style-type: none"> BW: DC to 50 MHz (-3 dB) Max. continuous input range: 30 A_{rms} Max. peak-peak current value: 50 A peak, non-continuous Compatibility: MSO/DS7000, MSO8000/A, DHO4000, MHO/DHO5000, and DS70000/80000 series
 <p>PCA1150</p>	Current Probe	<ul style="list-style-type: none"> BW: DC to 10 MHz (-3 dB) Max. continuous input range: 150 A Max. peak-peak current value: 300 A (non-continuous), 500 A (pulse width $\leq 30\text{ }\mu\text{s}$) Compatibility: MSO/DS7000, MSO8000/A, DHO4000, MHO/DHO5000, and DS70000/80000 series
 <p>PCA2030</p>	Current Probe	<ul style="list-style-type: none"> BW: DC to 100 MHz (-3 dB) Max. continuous input range: 30 A_{rms} Max. peak-peak current value: 50 A peak, non-continuous Compatibility: MSO/DS7000, MSO8000/A, DHO4000, MHO/DHO5000, and DS70000/80000 series
 <p>PCA1500</p>	Current Probe	<ul style="list-style-type: none"> BW: DC to 2 MHz (-3 dB) Max. continuous input range: $500\text{ A}_{\text{rms}}$ Max. peak-peak current value: 700 A peak, non-continuous Compatibility: MSO/DS7000, MSO8000/A, DHO4000, MHO/DHO5000, and DS70000/80000 series

Model	Type	Description
 <p>RP1001C</p>	Current Probe	<ul style="list-style-type: none"> BW: DC to 300 kHz Maximum Input AC: ± 100 A AC P-P: 200 A AC RMS: 70 A Compatibility: All models of RIGOL's digital oscilloscopes
 <p>RP1002C</p>	Current Probe	<ul style="list-style-type: none"> BW: DC to 1 MHz Maximum Input AC: ± 70 A AC P-P: 140 A AC RMS: 50 A Compatibility: All models of RIGOL's digital oscilloscopes
 <p>RP1003C</p>	Current Probe	<ul style="list-style-type: none"> BW: DC to 50 MHz Maximum Input AC P-P: 50 A (non-continuous) AC RMS: 30 A Compatibility: All models of RIGOL's digital oscilloscopes Required to order RP1000P power supply.
 <p>RP1004C</p>	Current Probe	<ul style="list-style-type: none"> BW: DC to 100 MHz Maximum Input AC P-P: 50 A (non-continuous) AC RMS: 30 A Compatibility: All models of RIGOL's digital oscilloscopes Required to order RP1000P power supply.
 <p>RP1005C</p>	Current Probe	<ul style="list-style-type: none"> BW: DC to 10 MHz Maximum Input AC P-P: 300 A (non-continuous), 500 A (@pulse width ≤ 30 us) AC RMS: 150 A Compatibility: All models of RIGOL's digital oscilloscopes Required to order RP1000P power supply.

Model	Type	Description
 RP1006C	Current Probe	<ul style="list-style-type: none"> BW: DC to 2 MHz Maximum Input AC P-P: 700 A peaks, non-continuous AC RMS: 500 A Compatibility: All models of RIGOL's digital oscilloscopes Required to order RP1000P power supply.
 RP1000P	4-CH Power Supply	Power supply for RP1003C, RP1004C, RP1005C, and RP1006C; supporting 4 channels.
Optical-fiber Isolated Probe		
 PIA1000	Optical-fiber Isolated Probe	<ul style="list-style-type: none"> CMRR up to 180 dB BW: DC to 1 GHz 2-meter length fiber transmission cable (Std.) Compatibility: MHO/DHO5000 series
Logic Analyzer Probe		
 PLA3204	Active Logic Analyzer Probe	<ul style="list-style-type: none"> No. of Input Channels: 4 Threshold Range: ± 15 V Min. Voltage Swing: 500 mVpp Min. Detectable Pulse Width: 5 ns Max. Input Voltage: ± 40 Vpp Max. Input Dynamic Range: ± 10 V + Threshold Input Impedance: $100\text{ k}\Omega \pm 1\%$ Input Capacitance: about 11 pF Compatibility: MHO5000 series

Specifications

All the specifications are guaranteed except the parameters marked with "Typical" and the oscilloscope needs to operate for more than 30 minutes under the specified operation temperature.

Overview of the MHO/DHO5000 Series Technical Specifications

DHO5000 Series				
Model	DHO5058	DHO5054	DHO5108	DHO5104
Analog bandwidth (50 Ω , -3 dB)	500 MHz		1 GHz	
Analog bandwidth (1 M Ω , -3 dB)	500 MHz			
Calculated Rising Time under 50 Ω (10%-90%, typical)	≤ 750 ps		≤ 400 ps (single-channel ^[1] & half-channel ^[2]) ≤ 440 ps (full-channel ^[3])	
No. of Input Channels	DHO5058/DHO5108: 8 analog channels + 1 EXT channel DHO5054/DHO5104: 4 analog channels + 1 EXT channel			
Max. Sample Rate of Analog Channel	DHO5058/DHO5108: 4 GSa/s (single-channel ^[1] & half-channel ^[2]), 2 GSa/s (full-channel ^[3]) DHO5054/DHO5104: 4 GSa/s (single-channel ^[1] & half-channel ^[2] & full-channel ^[3])			
MHO5000 Series				
Model	MHO5056	MHO5054	MHO5106	MHO5104
Analog bandwidth (50 Ω , -3 dB)	500 MHz		1 GHz	
Analog bandwidth (1 M Ω , -3 dB)	500 MHz			
Calculated Rising Time under 50 Ω (10%-90%, typical)	≤ 750 ps		≤ 400 ps (single-channel ^[1] & half-channel ^[2]) ≤ 440 ps (full-channel ^[3])	

MHO5000 Series

No. of Input Channels	MHO5054/MHO5104: 4 analog channels + 1 EXT channel + 16 digital channels MHO5056/MHO5106: 6 analog channels + 1 EXT channel + 16 digital channels Note: The logic analyzer probe is required to be purchased to work with the digital channel.
Max. Sample Rate of Analog Channel	4 GSa/s (single-channel ^[1] & half-channel ^[2]), 2 GSa/s (full-channel ^[3])

Overview of the Technical Specifications

Max. Memory Depth	500 Mpts (single-channel ^[1] & half-channel ^[2]), 250 Mpts (full-channel ^[3])
Sampling Mode	Real-time Sampling
Max. Waveform Capture Rate	200,000 wfms/s (in Vector mode) 1,000,000 wfms/s (in Record mode)
Vertical Resolution	12-bit (up to 16-bit in high resolution mode)
Max. Frames of Waveform Recording	Max. 500,000 frames
Peak Detection	Captures 500 ps glitches
LCD Size and Type	10.1" capacitive multi-touch screen
Display Resolution	1280×800

Vertical System Analog Channel

Vertical System Analog Channel

Input Coupling	DC, AC, or GND
Input Impedance	1 M Ω \pm 1%, 50 Ω \pm 1%
Input Capacitance	19 pF \pm 3 pF
Probe Attenuation Coefficient	0.001X, 0.002X, 0.005X, 0.01X, 0.02X, 0.05X, 0.1X, 0.2X, 0.5X, 1X, 2X, 5X, 10X, 20X, 50X, 100X, 200X, 500X, 1000X, 2000X, 5000X, 10000X, 15000X, 20000X, 50000X, and user-defined
Probe Recognition	Auto-recognized RIGOL probe

Vertical System Analog Channel

	1 M Ω	CAT I 300 V _{rms} , 400 V _{pk} (DC + V _{peak})
	50 Ω	5 V _{rms}
Maximum Input Voltage		Whether the probe is used, the 50 Ω or 1 M Ω route does not allow transient overvoltage to occur.
	Remarks	Please use the instrument dedicated for the specified measurement category (not applicable to CAT II, III, and IV).
Vertical Resolution		12-bit (up to 16-bit in high resolution mode)
Effective Number of Bits (ENOB) ^[4] (Typical)	1 GHz BW	7.7
	500 MHz BW	7.7
	250 MHz BW	8
Vertical Sensitivity Range ^[5]	1 M Ω	100 μ V/div to 10 V/div
	50 Ω	100 μ V/div to 1 V/div
Offset Range	1 M Ω	± 1 V (≥ 1 mV/div, ≤ 65 mV/div) ± 10 V (> 65 mV/div, ≤ 270 mV/div) ± 20 V (> 270 mV/div, ≤ 2.75 V/div) ± 100 V (> 2.75 V/div, ≤ 10 V/div)
	50 Ω	± 1 V (≥ 1 mV/div, ≤ 135 mV/div) ± 4 V (> 135 mV/div)
Dynamic Range		± 4 div (12 bits)
Bandwidth Limit (Typical)		20 MHz, 250 MHz, FULL; selectable for each channel <ul style="list-style-type: none"> The bandwidth limit is automatically set to 250 MHz when the vertical scale is ≤ 500 μV. The bandwidth limit is automatically set to 20 MHz when the vertical scale is ≤ 200 μV.
DC Gain Accuracy ^[5]		$\pm 2\%$ (< 5 mV); $\pm 1\%$ (≥ 5 mV)
DC Offset Accuracy		≤ 200 mV/div (± 0.1 div ± 2 mV $\pm 1.5\%$ of offset value) > 200 mV/div (± 0.1 div ± 2 mV $\pm 1.0\%$ of offset value)
Channel-to-Channel Isolation		$\geq 100:1$ (from DC to 500 MHz), $\geq 30:1$ (from > 500 MHz to rated bandwidth)

Vertical System Analog Channel

ESD Tolerance ± 8 kV (on input BNCs)

Vertical System Digital Channel^[6]

Vertical System Digital Channel

Number of Channels	16 input channels (D0 to D15) (D0 to D3, D4 to D7, D8 to D11, D12 to D15)
Threshold Range	± 15.0 V, in 10 mV step
Threshold Accuracy	$\pm (100.00$ mV + 3% of threshold setting)
Threshold Selection	TTL(1.4 V), CMOS5.0(2.5 V), CMOS3.3(1.65 V), CMOS2.5(1.25 V), CMOS1.8(0.9 V), ECL(-1.3 V), PECL(3.7 V), LVDS(1.2 V), 0.0 V User (adjustable threshold for 4 channels in a group)
Max. Input Voltage	± 40 V peak CAT I; transient overvoltage 800 Vpk
Max. Input Dynamic Range	± 10 V + threshold
Minimum Voltage Swing	500 mVpp
Input Impedance	100 k Ω \pm 1%
Probe Load	About 11 pF
Vertical Resolution	1-bit

Noise Floor

Noise Floor at 50 Ω (1 GHz BW)

100 μ V/div (20 MHz BW Limit)	31.2 μ V _{rms}
200 μ V/div (20 MHz BW Limit)	66 μ V _{rms}
500 μ V/div (250 MHz BW Limit)	74.4 μ V _{rms}
1 mV/div	139.2 μ V _{rms}
2 mV/div	136.8 μ V _{rms}
5 mV/div	145.2 μ V _{rms}
10 mV/div	406.8 μ V _{rms}
20 mV/div	465.6 μ V _{rms}

Noise Floor at 50 Ω (1 GHz BW)

50 mV/div	694.8 μV_{rms}
100 mV/div	1152 μV_{rms}
200 mV/div	4.92 mV _{rms}
500 mV/div	7.2 mV _{rms}
1 V/div	11.52 mV _{rms}

Noise Floor at 1 M Ω (500 MHz BW)

100 $\mu\text{V}/\text{div}$ (20 MHz BW Limit)	54 μV_{rms}
200 $\mu\text{V}/\text{div}$ (20 MHz BW Limit)	52.8 μV_{rms}
500 $\mu\text{V}/\text{div}$ (250 MHz BW Limit)	78 μV_{rms}
1 mV/div	130.8 μV_{rms}
2 mV/div	127.2 μV_{rms}
5 mV/div	153.6 μV_{rms}
10 mV/div	270 μV_{rms}
20 mV/div	331.2 μV_{rms}
50 mV/div	614.4 μV_{rms}
100 mV/div	3 mV _{rms}
200 mV/div	3.6 mV _{rms}
500 mV/div	12.84 mV _{rms}
1 V/div	16.08 mV _{rms}
2 V/div	24.36 mV _{rms}
5 V/div	117.84 mV _{rms}
10 V/div	156.36 mV _{rms}

Horizontal System--Analog Channel

Horizontal System--Analog Channel	
Range of Time Base	200 ps/div to 500 s/div Fine adjustment supported
Time Base Resolution	20 ps
Time Base Accuracy	$\pm 1.5 \text{ ppm} \pm 1 \text{ ppm/year}$
Time Base Delay Range	Pre-trigger -5 div
	Post-trigger 1 s or 100 div, whichever is greater
Delta Time Accuracy	$\pm(\text{Time Base Accuracy} \times \text{Readout}) \pm (0.001 \times \text{Screen Width}) \pm 20 \text{ ps}$
Channel-to-Channel Skew Correction	Channel-to-Channel Skew Correction Range $\pm 100 \text{ ns}$, Accuracy $\pm 1 \text{ ps}$
Analog Channel-to-Channel Delay (Typical)	$\leq 200 \text{ ps}^{[7]}$
Horizontal Mode	YT Default
	XY CH 1/2/3/4/5/6/7/8
	SCAN Time base $\geq 200 \text{ ms/div}$
	ROLL Time base $\geq 50 \text{ ms/div}$ or $\geq 100 \text{ ms/div}$ (selectable), available to enter or exit the ROLL mode by rotating the Horizontal SCALE knob

Acquisition System

Acquisition System	
Max. Sample Rate of Analog Channel	DHO5058/DHO5108 and MHO series: 4 GSa/s (single-channel ^[1] & half-channel ^[2]), 2 GSa/s (full-channel ^[3]) DHO5054/DHO5104: 4 GSa/s (single-channel ^[1] & half-channel ^[2] & full-channel ^[3])
Max. Memory Depth of Analog Channel	500 Mpts (single-channel ^[1] & half-channel ^[2]), 250 Mpts (full-channel ^[3])

Acquisition System

	Normal	Default
Acquisition Mode	Peak Detection	Captures 500 ps glitches
	Average Mode	2, 4, 8, 16...65536 are available for you to choose
	High Resolution	14-bit, 16-bit
	Waveform Recording	Waveform capture rate up to 1,000,000 wfms/s
	Vector Mode	Waveform capture rate \leq 200,000 wfms/s

Trigger System

Trigger System

Trigger Source	Analog channel (1~8), EXT TRIG, AC Line	
Trigger Mode	Auto, Normal, Single	
Trigger Coupling	DC	DC coupling trigger
	AC	AC coupling trigger, cut-off frequency~16 kHz (internal trigger only)
	High Frequency Rejection	High frequency rejection, cut-off frequency~200 kHz (internal trigger only)
	Low Frequency Rejection	Low frequency rejection, cut-off frequency~180 kHz (internal trigger only)
Noise Rejection	Increases delay for the trigger circuit (internal trigger only), On/Off	
Holdoff Range	8 ns to 10 s	
Trigger Bandwidth	Internal Trigger	Analog Bandwidth
	External Trigger	200 MHz

Trigger System

Trigger Sensitivity	Internal Trigger	0.50 div, ≥ 50 mV/div 0.7 div (with noise rejection enabled)
	External Trigger	200 mVpp, DC to 100 MHz 500 mVpp, 100 MHz to 200 MHz
EXT TRIG	Input Impedance	1 M Ω \pm 1%, BNC connector
	Trigger Jitter (Typical)	<1 ns _{rms} Normal acquisition, Edge trigger, trigger level located near 50% of EXT input signal
Trigger Level Range	Internal Trigger	\pm 5 div from the center of the screen
	External Trigger	\pm 5 V
	AC Line	Trigger level fixed between 40% and 60%

Trigger Type

Trigger Type

Trigger Type	Standard: Edge trigger, Pulse trigger, Slope trigger, Video trigger, Pattern trigger, Duration trigger, Timeout trigger, Runt trigger, Window trigger, Delay trigger, Setup/Hold trigger, Nth Edge trigger, I2C, SPI, and RS232/UART Option: CAN, CAN-FD, LIN, FlexRay, I2S, and MIL-STD-1553
Edge	Triggers on the threshold of the specified edge of the input signal. The edge types can be Rising, Falling, or Either. Source channel: CH1 to CH8, D0 to D15 ^[6] , EXT, and AC Line
Pulse	Triggers on the positive or negative pulse with a specified width. The pulse width is greater or smaller than a certain value or within a certain time range. Source channel: CH1 to CH8, D0 to D15 ^[6] .
Slope	Triggers on the positive or negative slope of the specified time. The slew time is greater or smaller than a certain value or within a certain time range. Source channel: CH1 to CH8.

Trigger Type

Video	<p>Triggers on all lines, specified line, add field, or even field that conforms to the video standards. The supported video standards include NTSC, PAL/SECAM, 480p/60Hz, 576p/50Hz, 720p/60Hz, 720p/50Hz, 720p/30Hz, 720p/25Hz, 720p/24Hz, 1080p/60Hz, 1080p/50Hz, 1080p/25Hz, 1080p/24Hz, 1080i/60Hz, and 1080i/50Hz.</p> <p>Source channel: CH1 to CH8.</p>
Pattern	<p>Identifies a trigger condition by searching for a specified pattern. The pattern is a combination of multiple selected channel sources. The logic pattern of each channel is H, L, X, Rising, or Falling.</p> <p>Source channel: CH1 to CH8, D0 to D15^[6].</p>
Duration	<p>Triggers when the specified pattern meets the specified duration condition. The pattern is a combination of multiple selected channel sources. The logic pattern of each channel is H, L, and X. The duration is greater or smaller than a certain value, or within a certain time range, or outside a certain time range.</p> <p>Source channel: CH1 to CH8, D0 to D15^[6].</p>
Timeout	<p>Triggers when duration of a certain event exceeds the specified time. The event can be specified as Rising, Falling, or Either.</p> <p>Source channel: CH1 to CH8, D0 to D15^[6].</p>
Runt	<p>Triggers when the pulses pass through one threshold but fail to pass through another threshold.</p> <p>Source channel: CH1 to CH8.</p>
Window	<p>Triggers in a specified window state when the rising edge of the signal crosses the upper threshold or the falling edge crosses the lower threshold. The window state can be Enter, Exit, or Time.</p> <p>Source channel: CH1 to CH8.</p>
Duration	<p>Triggers when the time difference between the specified edges of Source A and Source B meets the preset time. The duration is greater or smaller than a certain value, or within a certain time range, or outside a certain time range.</p> <p>Source channel: CH1~CH8</p>
Setup/Hold	<p>When the setup time or hold time between the input clock signal and the data signal is smaller than the specified time.</p> <p>Source channel: CH1 to CH8.</p>
Nth Edge	<p>Triggers on the Nth edge that appears after the specified idle time. The edge can be specified as Rising or Falling.</p> <p>Source channel: CH1 to CH8, D0 to D15^[6].</p>
RS232/UART	<p>Triggers on the Start, Error, Check Error, or Data frame of the RS232/UART bus (up to 20 Mb/s).</p> <p>Source channel: CH1 to CH8, D0 to D15^[6].</p>

Trigger Type	
I2C	<p>Triggers on the Start, Stop, Restart, MissedACK, Address (7 bits, 8 bits, or 10 bits), Data, or Address Data of the I2C bus.</p> <p>Source channel: CH1 to CH8, D0 to D15^[6].</p>
SPI	<p>Triggers on the specified pattern of the specified data width (4~32) of SPI bus. CS and Timeout are supported.</p> <p>Source channel: CH1 to CH8, D0 to D15^[6].</p>
CAN (Option)	<p>MHO/DHO5000-AUTOA option</p> <p>Triggers on the start of a frame, end of a frame, Remote ID, Overload, Frame ID, Frame Data, Data&ID, Frame Error, Answer Error, Check Error, Format Error, Bit Fill, and Random of the CAN signal (up to 5Mb/s). The supported CAN bus signal types include CAN_H, CAN_L, TX/RX, and DIFF.</p> <p>Source channel: CH1 to CH8, D0 to D15^[6].</p>
CAN-FD (Option)	<p>MHO/DHO5000-AUTOA option</p> <p>Triggers on the start of a frame, end of a frame, Remote ID, Overload, Frame ID, Frame Data, Data&ID, Frame Error, Bit Fill, Answer Error, Check Error, Format Error, and Random Error of the CAN-FD signal (up to 10 Mb/s). The supported CAN bus signal types include CAN_H, CAN_L, TX/RX, and DIFF.</p> <p>Source channel: CH1 to CH8, D0 to D15^[6].</p>
FlexRay (Option)	<p>MHO/DHO5000-FLEXA option</p> <p>Triggers on the specified position (TSS End, FSS_BSS End, FES End, DTS End), frame (null, Syn, Start, All), symbol (CAS/MTS and WUS), error (Head CRC Err, Tail CRC Err, Decode Err, and Random Err) of the FlexRay signal (up to 10 Mb/s).</p> <p>Source channel: CH1 to CH8, D0 to D15^[6].</p>
LIN(Option)	<p>MHO/DHO5000-AUTOA option</p> <p>Triggers on the Sync, ID, Data (length settable), Data&ID, Wakeup, Sleep, and Error of the LIN bus signal (up to 20 Mb/s).</p> <p>Source channel: CH1 to CH8, D0 to D15^[6].</p>
I2S (Option)	<p>MHO/DHO5000-AUDIOA option</p> <p>Triggers on 2's complement data of audio left channel, right channel, or either channel (=, ≠, >, <, <>, ><). The available alignment modes include I2S, LJ, and RJ.</p> <p>Source channel: CH1 to CH8, D0 to D15^[6].</p>
MIL-STD-1553 (Option)	<p>MHO/DHO5000-AEROA option</p> <p>Triggers on Sync (Data Sync, Cmd/Status Sync, and All Sync), Data, RTA, RTA +11Bit, and Error (Sync Error and Check Error) of the MIL-STD-1553 bus.</p> <p>Source channel: CH1 to CH8.</p>

Search & Navigate

Search & Navigate	
Type	Edge, Pulse
Source	Analog channels
Copy	Copy to/from trigger; independent settings including threshold and trigger condition setup
Result Display	Event list or be exported to external/internal memory
Navigate	Time: view acquired waveforms in time order
	Event: use the navigation controls to go to found search events
	Segments: use the navigation controls to play through the acquired segments in UltraAcquire mode

Waveform Measurement

Waveform Measurement		
Cursor	Number of Cursors	2 pairs of XY cursors
	Manual Mode	Voltage deviation between cursors (ΔY)
		Time deviation between cursors (ΔX)
		Reciprocal of ΔX (Hz) ($1/\Delta X$)
	Track Mode	Fixes Y-axis to track X-axis waveform point's voltage and time values Fixes X-axis to track Y-axis waveform point's voltage and time values
Auto Measurement	Allows to display cursors during auto measurement	
XY Mode	Measures the voltage parameters of the corresponding channel waveforms in XY time base mode. X = Channel 1, Y = Channel 2	

Waveform Measurement

	Number of Measurements	41 auto measurements; and up to 14 measurements can be displayed at a time.
	Measurement Source	CH1-CH8, D0-D15, Math1-Math4
	Measurement Range (Region)	Main, Zoom
	All Measurement	Displays 33 measurement items (vertical and horizontal) for the current measurement channel; the measurement results are updated continuously.
Auto Measurement	Vertical	Vmax, Vmin, Vpp, Vtop, Vbase, Vamp, Vupper, Vmid, Vlower, Vavg, VRMS, Per. VRMS, Overshoot, Preshoot, Area, and Period Area.
	Horizontal	Period, Frequency, Rise Time, Fall Time, +Width, -Width, +Duty, -Duty, Positive Pulse Count, Negative Pulse Count, Rising Edge Count, Falling Edge Count, Tvmax, Tvmin, +Slew Rate, and -Slew Rate
	Others	Delay(A↑-B↑), Delay(A↑-B↓), Delay(A↓-B↑), Delay(A↓-B↓), Phase(A↑-B↑), Phase(A↑-B↓), Phase(A↓-B↑), and Phase(A↓-B↓)
	Statistics	Items: Current, Average, Max, Min, Standard Deviation, Count Statistical times settable

Waveform Math

Waveform Math

	Number of Math Functions	4 math functions can be displayed simultaneously
	Arithmetic	A+B, A-B, A×B, A/B, FFT, A&&B, A B, A^B, !A, Intg, Diff, Lg, Ln, Exp, Sqrt, Abs, AX+B, LowPass, HighPass, BandPass, and BandStop
	Color Grade	FFT supported

Waveform Math

	Record Length	Up to 1 Mpts
FFT	Window Type	Rectangular, Blackman-Harris, Hanning (default), Hamming, Flattop, and Triangle
	Peak Search	A maximum of 15 peaks, determined by the settable threshold and offset threshold set by users

Waveform Analysis

Waveform Analysis

		Stores the signal under test in segments according to the trigger events, i.e. save all the sampled waveform data as a segment to the RAM for each trigger event. The maximum number of the sampled segments reaches 500,000.
Waveform Recording	Source	All enabled analog channels and digital channels
	Analysis	Supports playing frame by frame or continuous playing; capable of calculating, measuring, and decoding the played waveforms
Pass/Fail Test		Compares the signal under test with the user-defined mask to provide the test results: the number of successful tests, failed tests, and the total number of tests. The pass/fail event can enable immediate stop, beeper, and the screenshot.
	Source	Any analog channel
Color Grade		A dimensional view for color grade waveforms, color grade > 16, 256-level color scale display
	Source	Any analog channel
	Color Theme	Temperature and intensity
	Mode	All modes available

Serial Decoding

Serial Decoding

Number of Decodings	Four protocol types can be decoded and enabled at the same time
---------------------	---

Serial Decoding

Decoding Type	Standard: Parallel, RS232/UART, I2C, and SPI Option: LIN, CAN, CAN-FD, FlexRay, I2S, and MIL-STD-1553
Parallel	Up to 4 bits of Parallel decoding, supporting any analog channel Support user-defined clock and auto clock settings. Source channel: CH1 to CH8, D0 to D15 ^[6]
RS232/UART	Decodes the RS232/UART (up to 20 Mb/s) bus's TX/RX data (5-9 bits), parity (Odd, Even, or None), and stop bits (1-2 bits) Source channel: CH1 to CH8, D0 to D15 ^[6] .
I2C	Decodes the address (with or without the R/W bit) of the I2C bus, data, and ACK. Source channel: CH1 to CH8, D0 to D15 ^[6] .
SPI	Decodes the MISO/MOSI data (4-32 bits) of the SPI bus. The available mode includes "Timeout" and "CS". Source channel: CH1 to CH8, D0 to D15 ^[6] .
CAN (Option)	MHO/DHO5000-AUTOA option Decodes the remote frame (ID, byte number, CRC), overload frame, and data frame (standard/extended ID, control domain, data domain, CRC, and ACK) of the CAN bus (up to 5 Mb/s). The supported CAN bus signal types include CAN_H, CAN_L, TX/RX, and DIFF. Source channel: CH1 to CH8
CAN-FD (Option)	MHO/DHO5000-AUTOA option Decodes the remote frame (ID, byte number, CRC), overload frame, and data frame (standard/extended ID, control domain, data domain, CRC, and ACK) of the CAN bus (up to 10 Mb/s). The supported CAN-FD bus signal types include CAN_H, CAN_L, TX/RX, and DIFF. Source channel: CH1 to CH8, D0 to D15 ^[6] .
LIN (Option)	MHO/DHO5000-AUTOA option Decodes the protocol version (1.X or 2.X) of the LIN bus (up to 20 Mb/s). The decoding displays sync, ID, data, and check sum. Source channel: CH1 to CH8, D0 to D15 ^[6] .

Serial Decoding

	MHO/DHO5000-FLEXA option
FlexRay (Option)	Decodes the frame ID, PL (payload), Header CRC, Cycle Count, Data, Tail CRC, and DTS of the FlexRay bus (up to 10 Mb/s). The supported signal types include BP, BM, and RX/TX. Source channel: CH1 to CH8, D0 to D15 ^[6] .
I2S (Option)	MHO/DHO5000-AUDIOA option Decodes I2S audio bus left channel data and right channel data, supporting 4-32 bits. The alignment modes include I2S, LJ, and RJ. Source channel: CH1 to CH8, D0 to D15 ^[6] .
MIL-STD-1553 (Option)	MHO/DHO5000-AEROA option Decodes the MIL-STD-1553 bus signal's data word, command word, and status word (address + last 11 bits). Source channel: CH1 to CH8

Bode Plot^[8]

Bode Plot

Start Freq	10 Hz to 24.99 MHz
Stop Freq ^[9]	20 Hz to 25 MHz
Points/Decade	10 to 100
Output Amplitude	HighZ: 20 mV to 5 V; 50 Ω : 10 mV to 2.5 V

Arbitrary Function Generator (AFG)^[10]

AFG (technical specifications are typical values)

Number of Channels	2
Output Mode	Normal (2-channel output)
Sample Rate	1 GSa/s
Vertical Resolution	16-bit
Max. Frequency	50 MHz

AFG (technical specifications are typical values)

Output Waveform Basic waveforms: Sine, Square, Pulse, Ramp, Noise
 Built-in waveforms: DC, Sinc, Exp.Rise, Exp. Fall, ECG, Gauss, Lorentz, and Haversine

2-CH Synchronization Accuracy 200 ps

Sine Frequency Range 1 μ Hz to 50 MHz

Flatness ± 0.5 dB (relative to 1 kHz)

Harmonic Distortion -40 dBc

Sine Spurious (non-harmonics) -40 dBc

Total Harmonic Distortion <1%

S/N Ratio 40 dB

Square/Pulse Frequency Range 1 μ Hz to 30 MHz

Rise/Fall Time ≥ 3 ns, adjustable

Square/Pulse Overshoot <5%

Duty 1%~ 99%, adjustable

Jitter (rms) 500 ps

Ramp Frequency Range 1 μ Hz to 2 MHz

Linearity 1%

Symmetry 0% to 100%

Noise Cut-off Bandwidth 100 MHz

Arbitrary Waveform Frequency Range 1 μ Hz to 10 MHz

Waveform Length 2 pts to 16 kpts

Load the Stored Waveforms

AFG (technical specifications are typical values)

Freq	Accuracy	100 ppm
	Resolution	0.1 Hz or 4-bit, whichever is greater
Amplitude	Output Range	2 mVpp to 10 Vpp (1 M Ω); 1 mVpp to 5 Vpp (50 Ω)
	Resolution	100 μ V or 3-bit, whichever is greater
	Accuracy	\pm (2% of setting + 1 mV) (Frequency = 1 kHz)
DC Offset	Range	-10 V to 10 V
	Resolution	100 μ V or 3-bit, whichever is greater
	Accuracy	\pm (2% of offset setting + 5 mV + 0.5% of amplitude)
Modulation	AM	Modulating waveform: Sine, Square, Triangle, UpRamp, DnRamp, Noise
		Carrier waveform: Sine, Square, Ramp
		Modulation Source: Internal
		Modulation Depth: 0% to 120%
Modulation	FM	Modulating Waveform: Sine, Square, Triangle, UpRamp, DnRamp, and Noise
		Carrier Waveform: Sine, Square, Ramp
		Modulation Source: Internal
		Frequency Deviation: 0 Hz to 1 kHz (limited by the carrier frequency setting; the sum of the frequency deviation and carrier frequency shall not exceed the upper limit of the carrier frequency)
Modulation	PM	Modulating Waveform: Sine, Square, Triangle, UpRamp, DnRamp, Noise
		Carrier Waveform: Sine, Square, Ramp
		Modulation Source: Internal
		Phase Shift: 0° to 360°, default 90%
Modulation	PM	Modulation Frequency: 2 mHz to 1 MHz
		Modulating Waveform: Sine, Square, Triangle, UpRamp, DnRamp, Noise
		Carrier Waveform: Sine, Square, Ramp
		Modulation Source: Internal
Modulation	PM	Phase Shift: 0° to 360°, default 90%
		Modulation Frequency: 2 mHz to 1 MHz
		Modulating Waveform: Sine, Square, Triangle, UpRamp, DnRamp, Noise
		Carrier Waveform: Sine, Square, Ramp
Modulation	PM	Modulation Source: Internal
		Phase Shift: 0° to 360°, default 90%
		Modulation Frequency: 2 mHz to 1 MHz
		Carrier Waveform: Sine, Square, Ramp

Auto

Auto

AutoScale	Minimum voltage greater than 10 mVpp, duty cycle greater than 1%, and frequency over 35 Hz
-----------	--

Digital Voltmeter

Digital Voltmeter

Source	Any analog channel
Function	DC, AC+DC _{rms} , AC _{rms}
Resolution	ACV/DCV: 4 bits
Limits Beeper	Supports upper/lower limit settings; sounds an alarm when the voltage value is inside or outside of the limit range

High-precision Frequency Counter

High-precision Frequency Counter

Source	Any analog channel and EXT	
Measure	Frequency, period, totalizer	
Counter	Resolution	3-6 digits, user-defined
	Max. Frequency	Max. analog bandwidth ¹¹
Totalizer	48-bit totalizer	
	Counts the number of the rising edges	
Time Reference	Internal reference	

Command Set

Command Set

Common Commands Support	Standard SCPI commands
Error Message Definition	Error Message
Support Status Report Mechanism	Status Reporting
Support Sync Mechanism	Synchronization

Display

Display	
LCD	10.1-inch capacitive multi-touch gesture-enabled display
Resolution	1280x800 (Screen Region) 16:9
Graticule	10 horizontal divisions x 8 vertical divisions
Persistence	Off, Infinite, variable persistence (100 ms to 10 s)
Brightness	256 intensity levels (LCD, HDMI)

Processor System

Processor System	
Processor	Cortex-A72 1.8GHz + Cortex-A53 1.4GHz 6-core
System Memory	4 GB RAM
Operating System	Android
Internal Non-volatile Memory	128 GB

I/O

I/O	
USB3.0 Host	1 on the front panel
USB3.0 Device	1 on the rear panel
LAN	1 on the rear panel, 10/100/1000 Base-T, supporting LXI-C
Web Remote Control	Supports Web Control interface (input the IP address of the oscilloscope into the Web browser to display the operation interface of the oscilloscope)

I/O

		BNC output on the rear panel. $V_o (H) \geq 2.5 \text{ V}$ open circuit, $\geq 1.0 \text{ V}$ 50Ω to GND $V_o (L) \leq 0.7 \text{ V}$ to load $\leq 4 \text{ mA}$, $\leq 0.25 \text{ V}$ 50Ω to GND
AUX Out	Trig Out	Outputs a pulse signal when the oscilloscope is triggered
	Pass/Fail	Outputs a pulse signal when a pass/fail event occurs. Supports user-defined pulse polarity and pulse time (100 ns to 10 ms)
	Rise Time	$\leq 1.5 \text{ ns}$
10 MHz Reference Clock Input/Output	Input Interface	1, BNC connector on the rear panel
	Output Interface	1, BNC connector on the rear panel
	Input Interface	50Ω , with the amplitude 130 mVpp to 4.1 Vpp (-10 dBm, 20 dBm), frequency $10 \text{ MHz} \pm 10 \text{ ppm}$
	Output Interface	50Ω , 1.5 Vpp sine waveform
HDMI HD	Video Output	1 on the rear panel, HDMI 1.4, A plug. Used to connect to an external monitor or projector
Probe Compensation Output		1 kHz frequency, 0.3 V amplitude, Square

Power Supply

Power Supply

Power Voltage	AC 100 V to 240 V, 50 Hz to 60 Hz
Power	Max. 350 VA (connect to various interfaces, USB, active probes)
Fuse	3.15 A, T degree, 250 V

Environment

Environment

Temperature Range	Operating	-10°C to $+50^\circ\text{C}$
	Non-operating	-30°C to $+60^\circ\text{C}$

Environment

Humidity Range	Operating	below +30°C: ≤90% RH (without condensation)
		+30°C to +40°C, ≤75% RH (without condensation)
		+40°C to +50°C, ≤45% RH (without condensation)
Non-operating	below 60°C: ≤90% RH (without condensation)	
Altitude	Operating	below 3,000 m
	Non-operating	Below 15,000 m

Warranty and Calibration Interval

Warranty and Calibration Interval

Warranty	Three years for the mainframe, excluding the probes and accessories.
Recommended Calibration Interval	18 months

Regulations

Regulations		
	Compliant with EMC DIRECTIVE 2014/30/EU, compliant with or higher than the standards specified in IEC 61326-1:2013/EN 61326-1:2013 Group 1 Class A	
	CISPR 11/EN 55011	
Electromagnetic Compatibility	IEC 61000-4-2:2008/EN 61000-4-2	±4.0 kV (contact discharge), ±8.0 kV (air discharge)
	IEC 61000-4-3:2002/EN 61000-4-3	3 V/m (80 MHz to 1 GHz); 3 V/m (1.4 GHz to 2 GHz); 1 V/m (2.0 GHz to 2.7 GHz)
	IEC 61000-4-4:2004/EN 61000-4-4	1 kV power line
	IEC 61000-4-5:2001/EN 61000-4-5	0.5 kV (phase-to-neutral voltage); 1 kV (phase-to-earth voltage); 1 kV (neutral-to-earth voltage)
	IEC 61000-4-6:2003/EN 61000-4-6	3 V, 0.15-80 MHz
	IEC 61000-4-11:2004/EN 61000-4-11	Voltage dip: 0% UT during half cycle; 0% UT during 1 cycle ; 70% UT during 25 cycles short interruption: 0% UT during 250 cycles
	Safety	EN 61010-1:2019
EN 61010-031:2015		
IEC 61010-1:2016		
IEC 61010-2-030:2017		
UL 61010-1:2012 R7		
UL 61010-2-31:2017 R2		
CAN/CSA-22.2 No. 61010-1-12:2017		
CAN/CSA-22.2 No. 61010-2-30:2018		
CAN/CSA-22.2 No. 61010-031-07:201		
Vibration	Meets GB/T 6587; class 2 random	
	Meets MIL-PRF-28800F and IEC60068-2-6; class 3 random	

Regulations

	Meets GB/T 6587-2012; class 2 random
Shock	Meets MIL-PRF-28800F and IEC 60068-2-27; class 3 random
	In non-operating conditions: 30 g, half-sine wave, 11 ms duration, 3 shocks along the main axis, total of 18 shocks

Mechanical Characteristics

Mechanical Characteristics

Dimensions	335 mm (W) x 235 mm (H) x 154 mm (D)
------------	--------------------------------------

Rack Mount Kit	5U
----------------	----

Weight ^[12]	Package excluded: 5.3 kg
------------------------	--------------------------

	Package included: 6.3 kg
--	--------------------------

Non-volatile Memory

Non-volatile Memory

	Setup/Image	setup (*.stp), image (*.png, *.bmp, *.jpg)
Data/File Storage	Waveform Data	CSV waveform data (*.csv), binary waveform data (*.bin), list data (*.csv), and reference waveform data (*.ref, *.csv, *.bin)
Internal Capacity		128 GB
Reference Waveform		Displays 10 internal waveforms
Setting		Storage limited by the capacity
USB Capacity		Standard storage device

NOTE:

[1]: Single-channel mode: If any one of the channels is enabled, it is called single-channel mode.

[2]: Half-channel: when CH1, CH3, CH5, and CH7 are all enabled or when CH2, CH4, CH6, and CH8 are all enabled, it is called half-channel mode.

[3]: Full-channel mode: If all of the channels are enabled, it is called full-channel mode.

[4]: 10.7421875 MHz, Full Scale, 100 mV/div, and 50 Ω.

[5]: 500 μV/div is a magnification of 1 mV/div setting. For vertical accuracy calculations, use full scale of 8 mV.

[6]: Digital channels are only supported by MHO5054, MHO5104, MHO5056, and MHO5106.

[7]: For any channel, under the same input impedance with DC-coupled, the Volts/div setting is the same for 100 mV/div and 200 mV/div.

[8]: The Bode plot function is the standard configuration only for MHO5054 and MHO5104 models.

[9]: The stop frequency shall be greater than the start frequency.

[10]: The AFG function can be configured as an option only for MHO5054 and MHO5104 models. It is not available for other models.

[11]: Take CH1 and CH2 as one group, CH3 and CH4 as one group, CH5 and CH6 as one group, CH7 and CH8 as one group; with one channel enabled in each group.

[12]: Standard configuration.

Order Information and Warranty Period

Order Information

Order Information	Order No.
Model	
500 MHz, 4 GSa/s, 12-bit, 4-CH	DHO5054
1 GHz, 4 GSa/s, 12-bit, 4-CH	DHO5104
500 MHz, 4 GSa/s, 12-bit, 4+16CH	MHO5054
1 GHz, 4 GSa/s, 12-bit, 4+16CH	MHO5104
500 MHz, 4 GSa/s, 12-bit, 6+16CH	MHO5056
1 GHz, 4 GSa/s, 12-bit, 6+16CH	MHO5106
500 MHz, 4 GSa/s, 12-bit, 8-CH	DHO5058
1 GHz, 4 GSa/s, 12-bit, 8-CH	DHO5108
Standard Accessories	
Power Cord Conforming to the Standard of the Destination Country	— —
USB Cable	— —
DHO5054/DHO5104/MHO5054/MHO5104: Passive HighZ Probe (500 MHz) x4	RP3500A
MHO5056/MHO5106: Passive HighZ Probe (500 MHz) x6	
DHO5058/DHO5108: Passive HighZ Probe (500 MHz) x8	
Recommended Accessory	
4 sets of 4-Channel Logic Analyzer Probe for MHO Series	PLA3204
Bandwidth Upgrade Option	

Order Information	Order No.
500 MHz-1 GHz Upgrade Option	DHO5004-BWU05T10 (4-channel model) DHO5008-BWU05T10 (8-channel model) MHO5004-BWU05T10 (4-channel model) MHO5006-BWU05T10 (6-channel model)
Protocol Decoding Option	
CAN/CAN-FD/LIN Bus Trigger and Analysis Option	DHO5000-AUTOA MHO5000-AUTOA
MIL-STD-1553 Bus Trigger and Analysis Option	DHO5000-AEROA MHO5000-AEROA
FlexRay Serial Bus Trigger and Analysis Option	DHO5000-FLEXA MHO5000-FLEXA
I2S Bus Trigger and Analysis Option	DHO5000-AUDIOA MHO5000-AUDIOA
Optional Accessories	
Built-in Dual-Channel 50 MHz Function Waveform Generator Option	MHO5000-AWG
Power Analysis Option	DHO5000-PWRA MHO5000-PWRA
Function and Application Bundle Option, including AUTOA/AEROA/FLEXA/AUDIOA/PWRA.	DHO5000-BND MHO5000-BND

Note:

For all the mainframes, accessories, and options, please contact the local office of RIGOL.

Warranty Period

Three years for the mainframe, excluding the probes and accessories.

Option Ordering and Installation Process

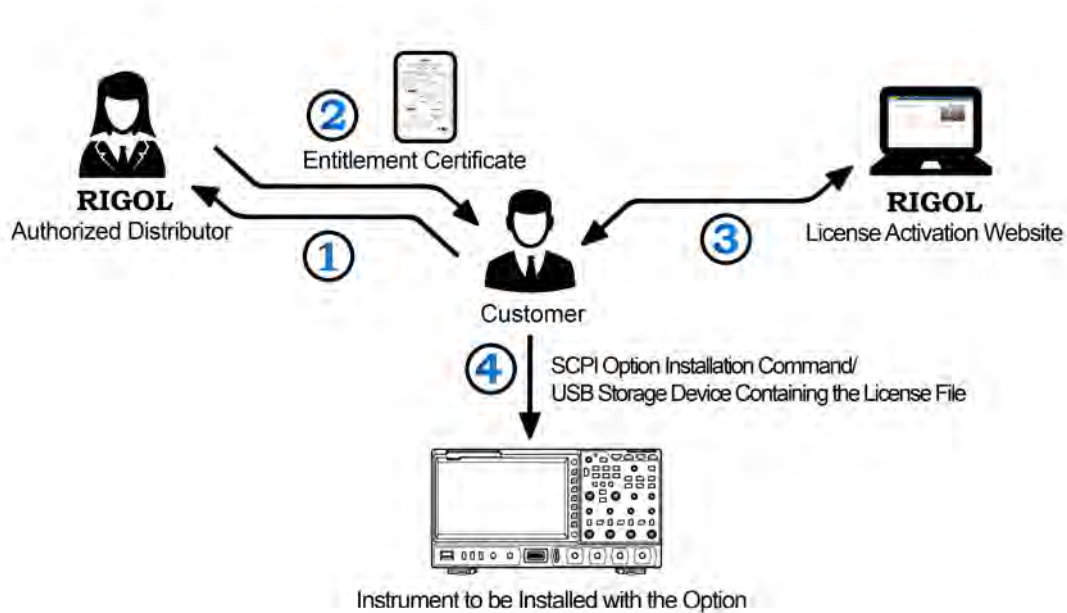

1. According to the usage requirements, please purchase the specified function options from **RIGOL Sales Personnel**, and provide the serial number of the instrument that needs to install the option.
2. After receiving the option order, the **RIGOL** factory will mail the paper software product entitlement certificate to the address provided in the order.
3. Log in to **RIGOL** official website for registration. Use the software key and instruments serial number provided in the entitlement certificate to obtain the option license code and the option license file.
4. Install the option by running the SCPI command concerning the option installation. You can also save the option license file to the root directory of the USB storage device. Then insert it to the instrument. After being recognized, follow the instructions to install the option.

NOTE:

If any problems occur during the option installation process, please contact **RIGOL** technical team.

Boost Smart World and Technology Innovation

Industrial Intelligent
Manufacturing



Semiconductors



Education &
Research

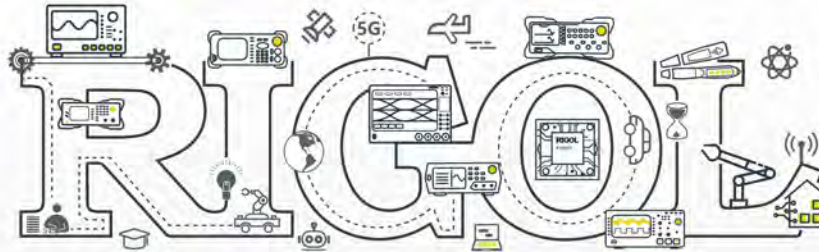

Communication

System Integration



New Energy



- 5G Cellular-5G/WIFI
- UWB/RFID/ ZIGBEE
- Digital Bus/Ethernet
- Optical Communication

- Digital/Analog/RF Chip
- Memory and MCU Chip
- Third-Generation Semiconductor
- Solar Photovoltaic Cells

- New Energy Automobile
- PV/Inverter
- Power Test
- Automotive Electronics

*Provide Testing and Measuring Products
and Solutions for Industry Customers*

HEADQUARTER

RIGOL TECHNOLOGIES CO., LTD.
No.8 Kelling Road, New District,
Suzhou, JiangSu, P.R.China
Tel: +86-400620002
Email: info@rigol.com

JAPAN

RIGOL JAPAN CO., LTD.
5F, 3-45-6, Minamiotsuka, Toshima-Ku,
Tokyo, 170-0005, Japan
Tel: +81-3-6262-8932
Fax: +81-3-6262-8933
Email: info.jp@rigol.com

EUROPE

RIGOL TECHNOLOGIES EU GmbH
Carl-Benz-Str.11
82205 Gilching
Germany
Tel: +49(0)8105-27292-0
Email: info-europe@rigol.com

KOREA

RIGOL KOREA CO., LTD.
5F, 222, Gonghang-daero,
Gangseo-gu, Seoul, Republic of Korea
Tel: +82-2-6953-4466
Fax: +82-2-6953-4422
Email: info.kr@rigol.com

NORTH AMERICA

RIGOL TECHNOLOGIES, USA INC.
10220 SW Nimbus Ave.
Suite K-7
Portland, OR 97223
Tel: +1-877-4-RIGOL-1
Fax: +1-877-4-RIGOL-1
Email: info@rigol.com

RIGOL® is the trademark of **RIGOL TECHNOLOGIES CO., LTD.** Product information in this document is subject to update without notice. For the latest information about **RIGOL's** products, applications and services, please contact local **RIGOL** channel partners or access **RIGOL** official website: www.rigol.com